

PS Series

Pushbutton Switches

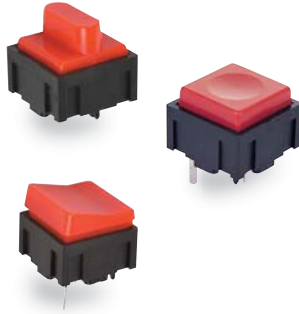

SPECIFICATIONS

RATING: 25mA @ 50VDC

ELECTRICAL LIFE: 10,000 cycles typical.

CONTACT RESISTANCE: 20 mΩ max. typical at 2-4VDC, 100mA

INSULATION RESISTANCE: 100 MΩ min.

DIELECTRIC STRENGTH: 500 V rms at sea level.

OPERATING FORCE: 250 ± 50gf

MATERIALS

HOUSING: Nylon 6/6.

COVER / CAP: ABS or polycarbonate.

DOME CONTACT: Gold over stainless steel.

TERMINALS / CONTACTS: Silver plated copper alloy.

HOW TO ORDER

Model No. Circuit Cap Style Cap Color

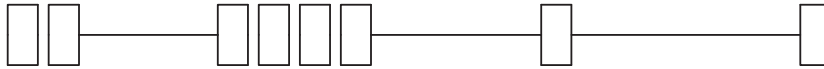

PS

1012

A
B
C
D
E
F

1 = White
2 = Black (Std)
3 = Red (Std)
4 = Orange
5 = Yellow
6 = Green
7 = Blue
8 = Brown
9 = Gray

* Besides standard color,
other colors need to check stocks available.

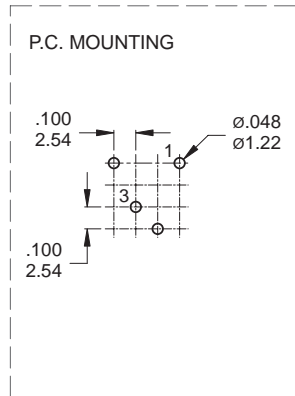
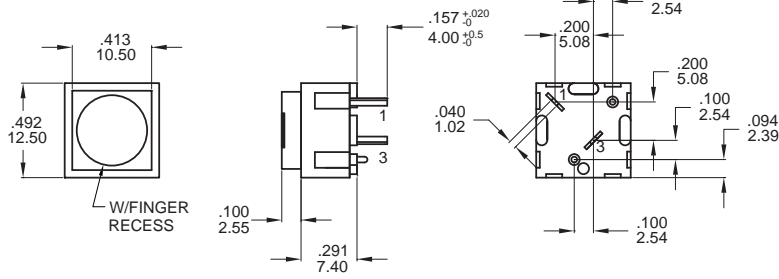

PS-1012-A3

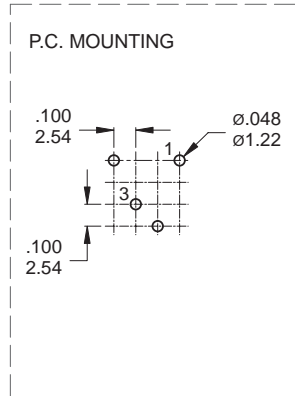
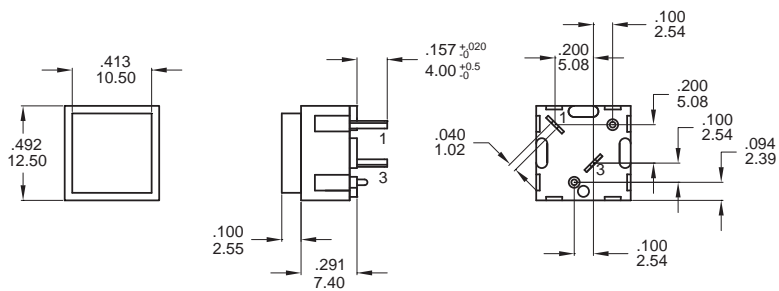

PS-1012-B2

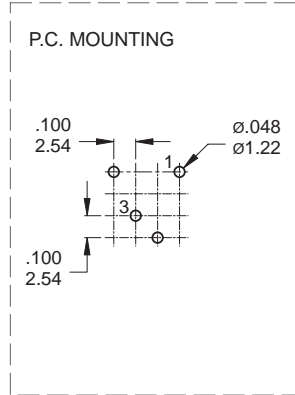
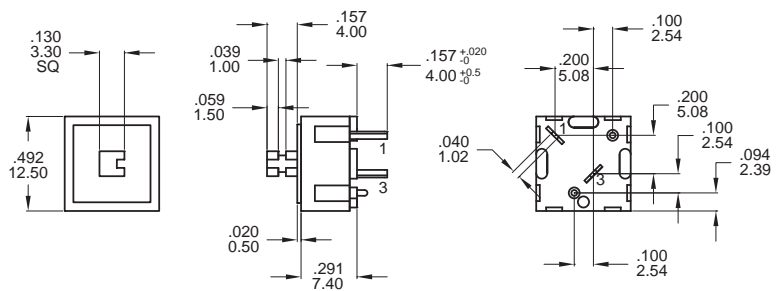

PS-1012-C2

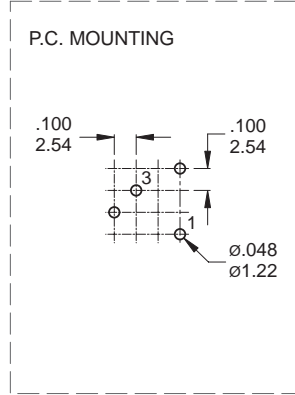
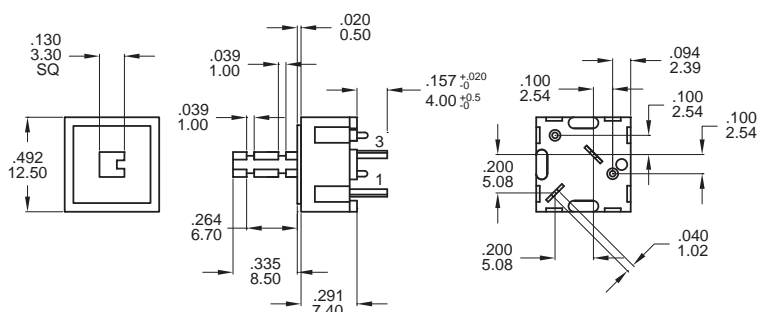

PS-1012-D2

PS Series

Pushbutton Switches



PS-1012-E3

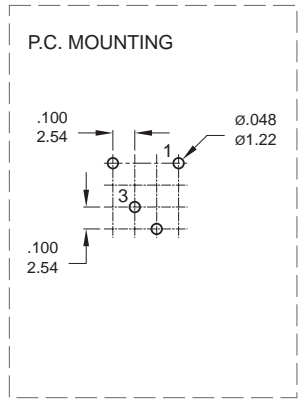
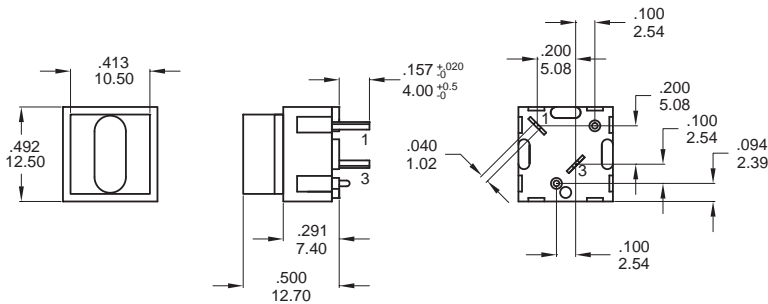

PS-1012-F3

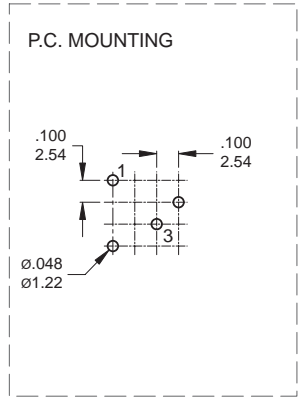
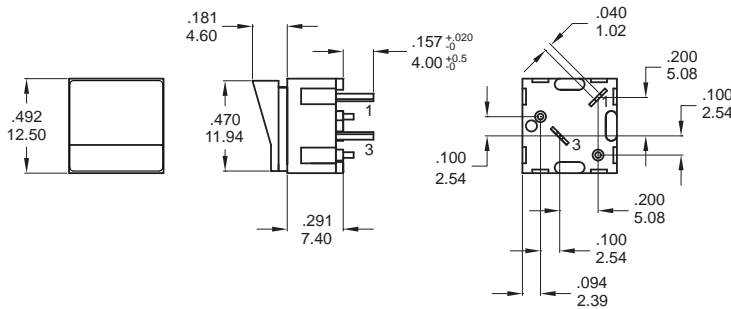

CAP OPTIONS

PS
Pushbutton Switches

	<i>PS001</i>	<i>PS002</i>	<i>PS003</i>	<i>PS004</i>	<i>PS005</i>	<i>PS006</i>
COLORS	Black White Gray	Black / White Gray / Red Chrome	Black / Gray White / Red	Black / Gray	Black / White Gray / Red Chrome / Blue	Black / Gray White / Red